

# CONSIGNES DE TRI

Le recyclage c'est simple !

## EMBALLAGES PLASTIQUES



## BOUTEILLES ET FLACONS PLASTIQUES

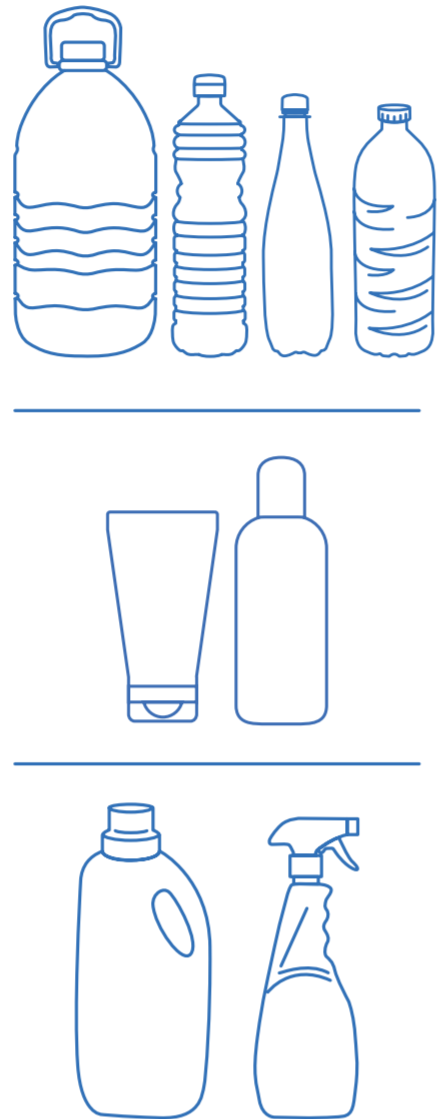

## PAPIERS ET CARTONS

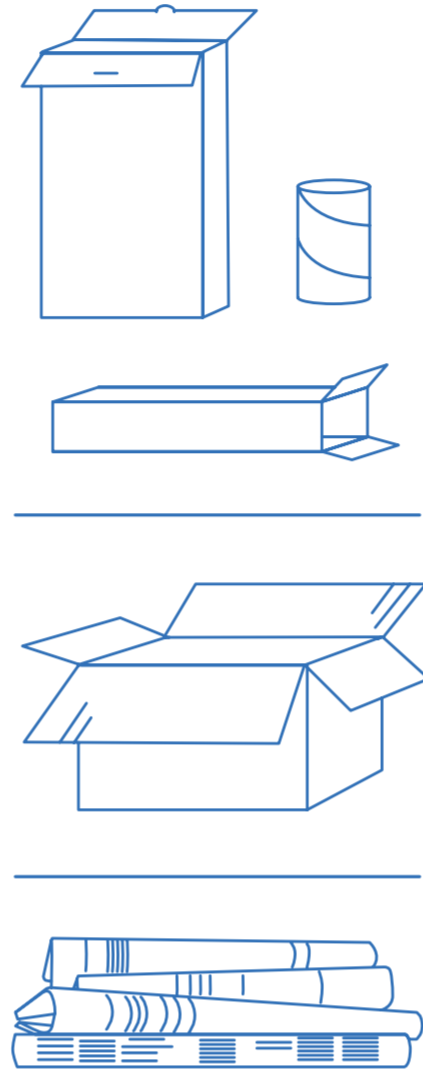

## EMBALLAGES MÉTALLIQUES

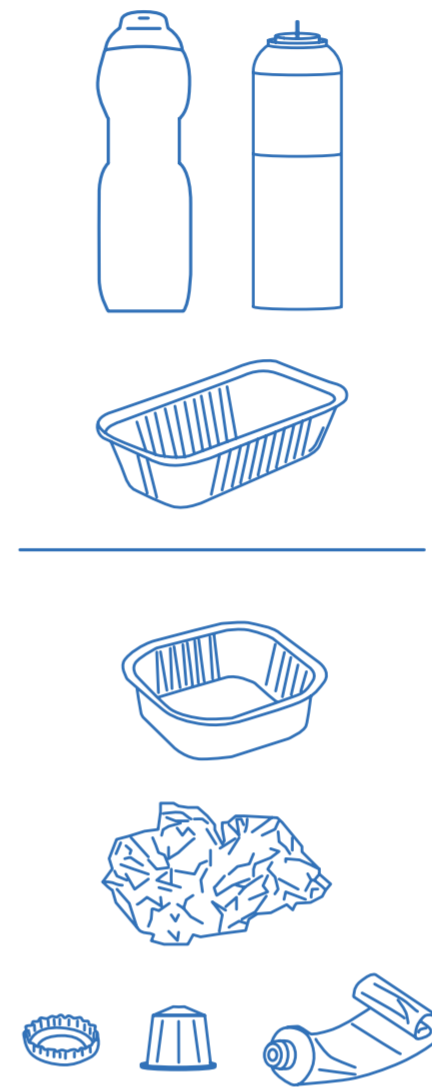

**EN VRAC !**  
Vidés, mais inutile de les laver : séparés, tous les emballages se trient

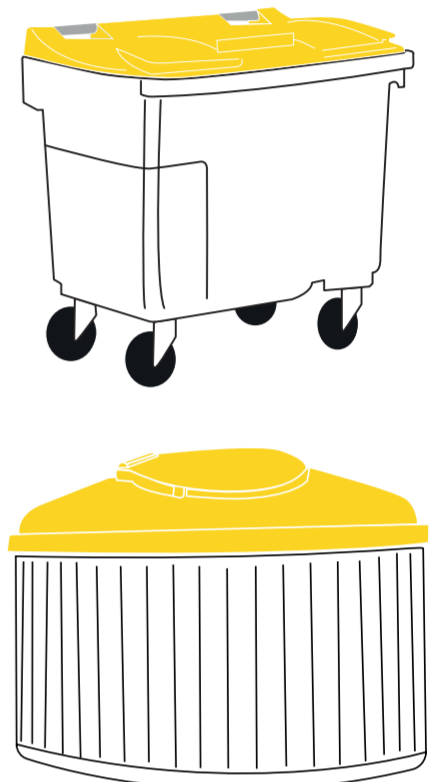

## EMBALLAGES EN VERRE

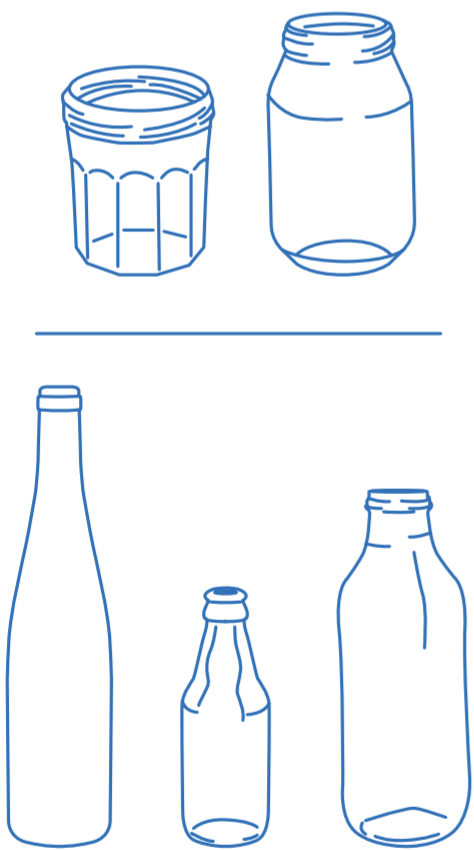

avec ou sans bouchons métalliques

**EN VRAC !**  
Même cassés, vidés mais inutile de les laver

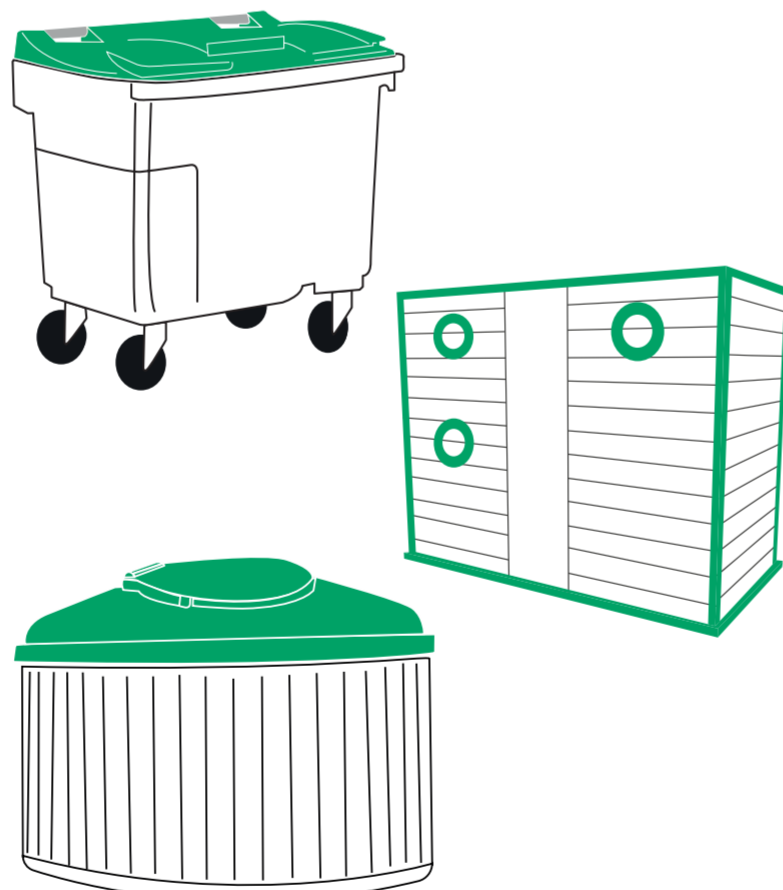

## ORDURES MÉNAGÈRES



**AUTRES DÉCHETS NON DANGEREUX**  
vaisselles cassées, petits objets en plastique (hors emballages), produits d'hygiène (masques, couches, mouchoirs usagers, etc., ...)

**TOUJOURS EN SAC !**  
Dans votre bac

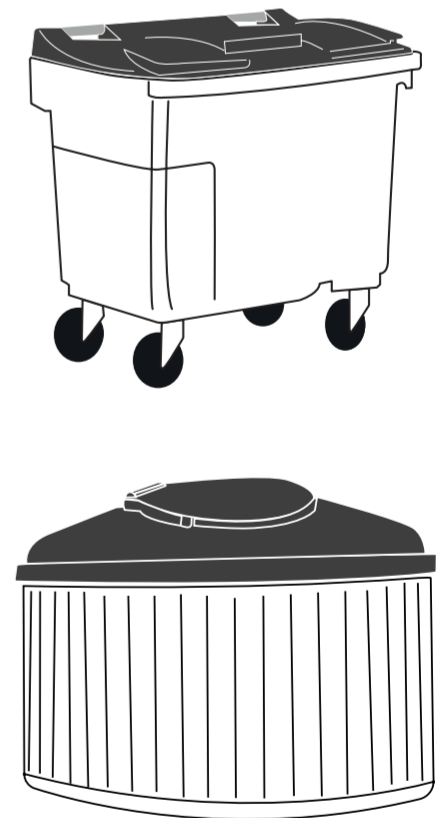

À APPORTER EN DÉCHÈTERIE



petits et grands électroménagers



déchets dangereux



pires et batteries



meubles



grands cartons



gravats



déchets verts

#ZéroDéchet

UN DOUTE ?  
UNE QUESTION ?

CITEO

05 57 76 17 17  
coban-atlantique.fr



COBAN  
COMMUNAUTÉ D'AGGLOMÉRATION  
DU BASSIN D'ARCACHON NORD